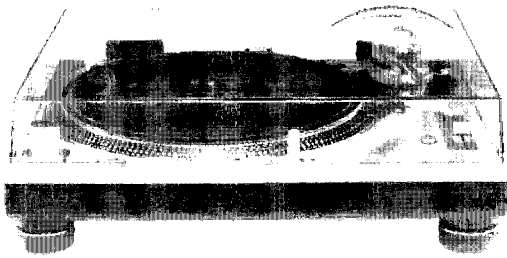


Turntable System

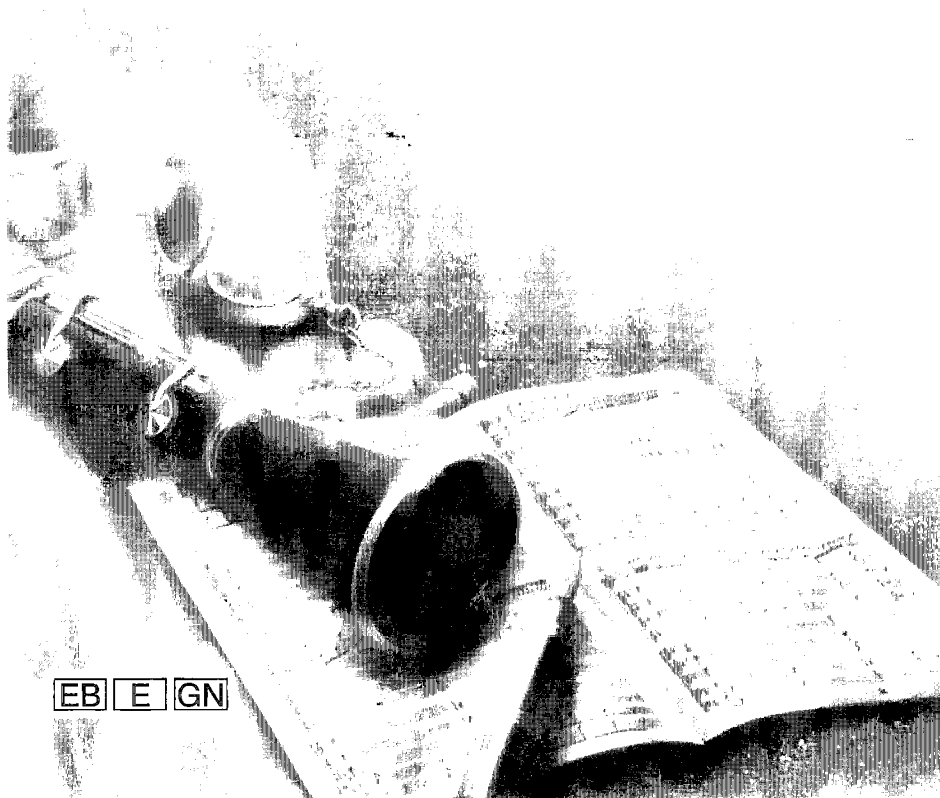
Operating Instructions

Model No. ***SL-1200MK5***
SL-1210MK5



SL-1200MK5

Technics®



Note:

"EB" on the packaging indicates the United Kingdom.

Before connecting, operating or adjusting this product, please read these instructions completely. Please keep this manual for future reference.

RQT7017-B

Thank you for purchasing this product.
For optimum performance and safety, please read these instructions carefully.

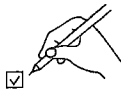
SL-1200MK5	Silver model
SL-1210MK5	Black model

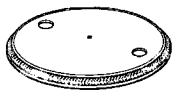

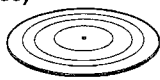




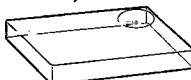

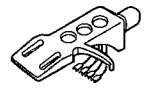


Table of contents

Supplied accessories	2
Caution for AC mains lead	4
Safety precautions	4
Features	5
Preparation of the cartridge	5
Controls	5
Putting the player together	6
Connections and installation	6
Connecting to an amplifier and AC mains lead	6
Connecting to an Audio Mixer (not included)	7
Installation	7
Preparatory adjustments	7
Horizontal balance and stylus pressure	7
Anti-skating	8
Armlift height	8
Tone arm height	8
Fit the dust cover	8
Playing records	9
Adjustments while using the unit	10
Pitch control	10
Adjusting the turntable brake speed	10
Maintenance	11
Troubleshooting guide	11
Specifications	11

Supplied accessories

Please check and identify the supplied accessories.
For the United Kingdom only:
Use numbers indicated in parentheses when asking for replacements parts.



<input type="checkbox"/> Turntable 1pc. (SFTE172-01Z1)	<input type="checkbox"/> Balance weight 1pc. (SFPWG17201K)
	
<input type="checkbox"/> Turntable mat 1pc. (RGS0008)	<input type="checkbox"/> Auxiliary weight 1pc. (SFPWG17202)
	
<input type="checkbox"/> Disc slip sheet set (RGS0005Z-1) 1	<input type="checkbox"/> EP record adaptor (SFWE010) 1pc.
• Disc slip sheet	
• Transparent sheet	<input type="checkbox"/> Shell weight 1pc. (SFPZB3501)
	
<input type="checkbox"/> Dust cover 1pc. (RYF0370B-X)	<input type="checkbox"/> Overhang gauge 1pc. (SFK0135-01)
	
<input type="checkbox"/> Head shell (SFPCC31001K) 1pc.	<input type="checkbox"/> Screw set for cartridge 1
	• Nuts(RHN26003)
	• Screws-short(SFCZV8801-1)
	• Screws-long(SFPEV9801-1)
	• Washers(SFPEW9601)
	
A cartridge is not included.	<input type="checkbox"/> Sticker 1pc. (RQLC0142-1)
	

For United Kingdom and Republic of Ireland

Panasonic	www.panasonic.co.uk (for UK customers only)
<ul style="list-style-type: none"> • Order accessory and consumable items for your product with ease and confidence by telephoning our Customer Care Centre Mon-Friday 9:00am-5:30pm. (Excluding public holidays.) • Or go on line through our Internet Accessory ordering application. • Most major credit and debit cards accepted. • All enquiries transactions and distribution facilities are provided directly by Panasonic UK Ltd. • It couldn't be simpler! 	
<p>Customer Care Centre For UK customers: 08705 357357 For Republic of Ireland customers: 01 289 8333</p>	
<p>Technical Support For UK customers: 0870 1 505610 This Technical Support Hot Line number is for Panasonic PC software related products only. For Republic of Ireland, please use the Customer Care Centre number listed above for all enquiries. For all other product related enquiries, please use the Customer Care Centre numbers listed above.</p>	

CAUTION!

- DO NOT INSTALL OR PLACE THIS UNIT IN A BOOKCASE, BUILT-IN CABINET OR IN ANOTHER CONFINED SPACE. ENSURE THE UNIT IS WELL VENTILATED. TO PREVENT RISK OF ELECTRIC SHOCK OR FIRE HAZARD DUE TO OVERHEATING, ENSURE THAT CURTAINS AND ANY OTHER MATERIALS DO NOT OBSTRUCT THE VENTILATION VENTS.
- DO NOT OBSTRUCT THE UNIT'S VENTILATION OPENINGS WITH NEWSPAPERS, TABLECLOTHS, CURTAINS, AND SIMILAR ITEMS.
- DO NOT PLACE SOURCES OF NAKED FLAMES, SUCH AS LIGHTED CANDLES, ON THE UNIT.
- DISPOSE OF BATTERIES IN AN ENVIRONMENTALLY FRIENDLY MANNER.

WARNING:

TO REDUCE THE RISK OF FIRE, ELECTRIC SHOCK OR PRODUCT DAMAGE, DO NOT EXPOSE THIS APPARATUS TO RAIN, MOISTURE, DRIPPING OR SPLASHING AND THAT NO OBJECTS FILLED WITH LIQUIDS, SUCH AS VASES, SHALL BE PLACED ON THE APPARATUS.

This product may receive radio interference caused by mobile telephones during use. If such interference is apparent, please increase separation between the product and the mobile telephone.

THIS UNIT IS INTENDED FOR USE IN MODERATE CLIMATES.

SUOMI**VAROITUS!**

- ÄLÄ ASENNATA TAI LAITTA TÄTÄ LAITETTA KABINETTITYYPPISEEN KIRJAKAAPPIIN TAI MUUHUN SULJETTUUN TILAAN, JOTTA TUULETUS ONNISTUISI. VARMISTA, ETTÄ VERHO TAI MIKÄÄN MUU MATERIAALI EI HUONONNA TUULETUSTA, JOTTA VÄLTETTÄISIIN YLIKUUMENEMISESTA JOHTUVA SÄHKÖISKU- TAI TULIPALOVAARA.
- ÄLÄ PEITÄ LAITTEEN TUULETUSAUKKOJA SANOMALEHDellä, PÖYTÄLIINALLA, VERHOLLA TAI MUULLA VASTAAVALLA ESINEELLÄ.
- ÄLÄ ASETA PALAVAA KYNTTILÄÄ TAI MUUTA AVOTULEN LÄHDETTÄ LAITTEEN PÄÄLLE.
- HÄVITÄ PARISTOT LUONTOA VAHINGOITTAMATTOMALLA TAVALLA.

VAROITUS:

TULIPALO-, SÄHKÖISKUVAARAN TAI TUOTETTA KOHTAAVAN MUUN VAHINGON VÄHENTÄMISEKSI EI LAITETTA SAA ALTISTAA SATEELLE, KOSTEUDELLE, VESIPISAROILLE TAI ROISKEELLE, EIKÄ NESTETTÄ SISÄLTÄVIÄ ESINEITÄ, KUTEN ESIMERKIKSI MALJAKOITA, SAA ASETTAA LAITTEEN PÄÄLLE.

TÄMÄ LAITE ON TARKOITETTU KÄYTETTÄVÄKSI LEUDOSSA ILMASTOSSA.

NORSK**ADVARSEL!**

- APPARATET MÅ IKKE PLOSSERES I EN BOKHYLLE, ET INNEBYGGET KABINETT ELLER ET ANNET LUKKET STED HVOR VENTILASJONSFORHOLDENE ER UTILSTREKKEELIGE. SØRG FOR AT GARDINER ELLER LIGNENDE IKKE FORVERRER VENTILASJONSFORHOLDENE, SÅ RISIKO FOR ELEKTRISK SJOKK ELLER BRANN FORÅRSAKET AV OVERHETING UNNGÅS.
- APPARATETS VENTILASJONSÅPNINGER MÅ IKKE DEKKES TIL MED AVISER, BORDDUKER, GARDINER OG LIGNENDE.
- PLOSSER IKKE ÅPEN ILD, SLIK SOM LEVENDE LYS, OPPÅ APPARATET.
- BRUKTE BATTERIER MÅ KASSERES UTEN FARE FOR MILJØET.

ADVARSEL:

FOR Å REDUSERE FAREN FOR BRANN, ELEKTRISK STØT ELLER SKADER PÅ PRODUKTET, MÅ DETTE APPARATET IKKE UTSETTES FOR REGN, FUKTIGHET, VANNDRÅPER ELLER VANNSPRUT. DET MÅ HELLER IKKE PLOSSERES GJENSTANDER FYLT MED VANN, SLIK SOM BLOMSTERVASER, OPPÅ APPARATET.

DETTE APPARATET ER BEREGNET TIL BRUK UNDER MODERATE KLIMAFORHOLD.



**(For the United Kingdom)
("EB" area code model only)**

For your safety, please read the following text carefully.

This appliance is supplied with a moulded three pin mains plug for your safety and convenience.

A 5-ampere fuse is fitted in this plug.

Should the fuse need to be replaced please ensure that the replacement fuse has a rating of 5-ampere and that it is approved by ASTA or BSI to BS1362.

Check for the ASTA mark  or the BSI mark  on the body of the fuse.

If the plug contains a removable fuse cover you must ensure that it is refitted when the fuse is replaced.

If you lose the fuse cover the plug must not be used until a replacement cover is obtained.

A replacement fuse cover can be purchased from your local dealer.

CAUTION!

IF THE FITTED MOULDED PLUG IS UNSUITABLE FOR THE SOCKET OUTLET IN YOUR HOME THEN THE FUSE SHOULD BE REMOVED AND THE PLUG CUT OFF AND DISPOSED OF SAFELY.

THERE IS A DANGER OF SEVERE ELECTRICAL SHOCK IF THE CUT OFF PLUG IS INSERTED INTO ANY 13-AMPERE SOCKET.

If a new plug is to be fitted please observe the wiring code as stated below.

If in any doubt please consult a qualified electrician.

IMPORTANT


The wires in this mains lead are coloured in accordance with the following code:

Blue: Neutral, Brown: Live.

As these colours may not correspond with the coloured markings identifying the terminals in your plug, proceed as follows:

The wire which is coloured Blue must be connected to the terminal which is marked with the letter N or coloured Black or Blue.

The wire which is coloured Brown must be connected to the terminal which is marked with the letter L or coloured Brown or Red.

WARNING: DO NOT CONNECT EITHER WIRE TO THE EARTH TERMINAL WHICH IS MARKED WITH THE LETTER E, BY THE EARTH SYMBOL  OR COLOURED GREEN OR GREEN/YELLOW.

THIS PLUG IS NOT WATERPROOF—KEEP DRY.

Before use

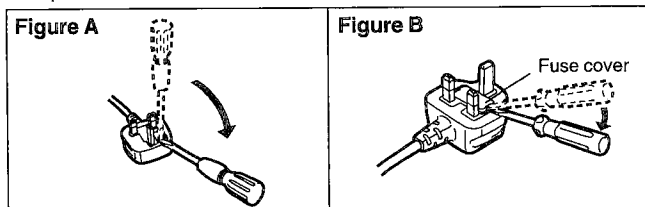
Remove the connector cover.

How to replace the fuse

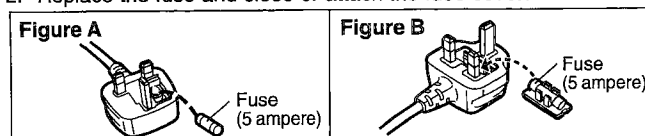
The location of the fuse differ according to the type of AC mains plug (figures A and B). Confirm the AC mains plug fitted and follow the instructions below.

Illustrations may differ from actual AC mains plug.

1. Open the fuse cover with a screwdriver.



2. Replace the fuse and close or attach the fuse cover.



Placement

Set the unit up on an even surface away from direct sunlight, high temperatures, high humidity, and excessive vibration. These conditions can damage the cabinet and other components, thereby shortening the unit's service life.

Do not place heavy items on the unit.

Voltage

Do not use high voltage power sources. This can overload the unit and cause a fire.

Do not use a DC power source. Check the source carefully when setting the unit up on a ship or other place where DC is used.

AC mains lead protection

Ensure the AC mains lead is connected correctly and not damaged. Poor connection and lead damage can cause fire or electric shock. Do not pull, bend, or place heavy items on the lead.

Grasp the plug firmly when unplugging the lead. Pulling the AC mains lead can cause electric shock.

Do not handle the plug with wet hands. This can cause electric shock.

Foreign matter

Do not let metal objects fall inside the unit. This can cause electric shock or malfunction.

Do not let liquids get into the unit. This can cause electric shock or malfunction. If this occurs, immediately disconnect the unit from the power supply and contact your dealer.

Do not spray insecticides onto or into the unit. They contain flammable gases which can ignite if sprayed into the unit.

Service

Do not attempt to repair this unit by yourself. If sound is interrupted, indicators fail to light, smoke appears, or any other problem that is not covered in these operating instructions occurs, disconnect the AC mains lead and contact your dealer or an authorized service center. Electric shock or damage to the unit can occur if the unit is repaired, disassembled or reconstructed by unqualified persons.

Extend operating life by disconnecting the unit from the power source if it is not to be used for a long time.

CAUTION:

The AC voltage is different according to the area. Be sure to set the proper voltage in your area before use. (For details, please refer to page 6.)

Features

A masterpiece amongst turntables with a worldwide reputation.

Highly accurate turntable speed maintained continuously with a quartz pitch control.

- The pitch can be varied throughout the range maintaining perfect accuracy.
- Pitch can be instantly reset to the rated speed (33 1/3 or 45 r/min) with the reset button.

The direct drive produces high torque.

- Wow and flutter below 0.01 %. Starting torque of 1.5 kg-cm enabling the turntable to reach 33 1/3 r/min in 0.7 seconds.
- Smooth stops are achieved with a fully electronic braking system. The braking speed can be adjusted with the brake speed control knob.

Tone arm with gimbals suspension

- Using the balance weight control measurement units on the tone arm, you can quickly change stylus pressure settings to the appropriate pressure.
- Stylus skipping can be reduced using horizontal weight control for scratch play.
- The tone arm can be finely adjusted in a range of 6 millimeters with the lockable height control.

Anti-vibration design with 3 layer cabinet construction and large insulating legs.

Pop-up stylus light.

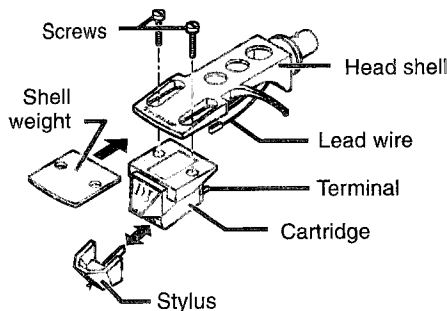
- A light illuminates the stylus.

Preparation of the cartridge

1 Attach a cartridge (not included).

Follow the cartridge's instructions to correctly attach it to the head shell.

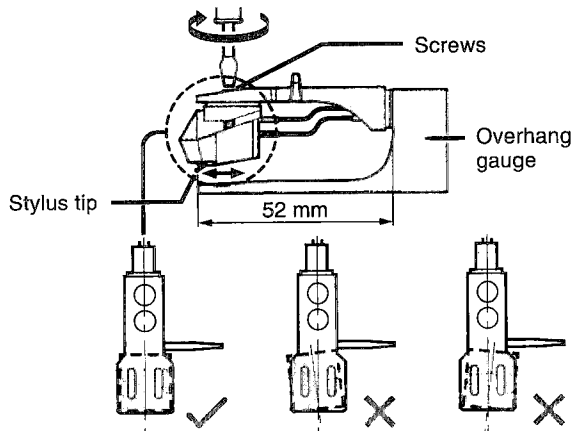
- Use the included shell weight when using a light cartridge (3.5 to 6.5 grams).



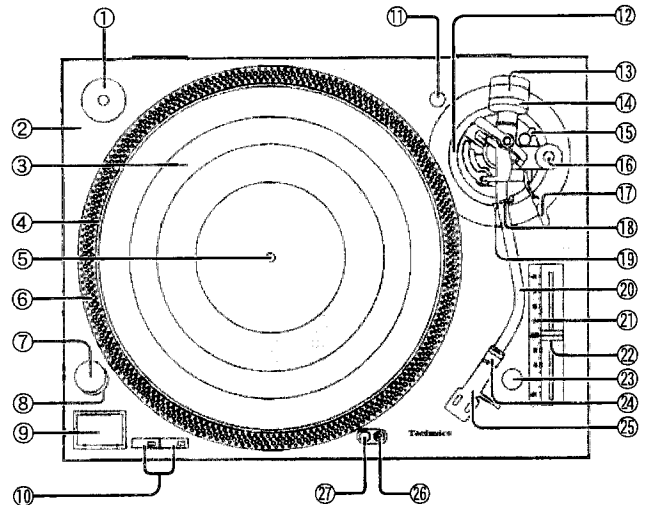
2 Adjust the overhang.

Fit the included overhang gauge to the head shell. Adjust the overhang and facing of the cartridge and tighten the screws.

- Line the stylus tip up with the end of the gauge.
- The cartridge should be parallel on the shell head.



Controls



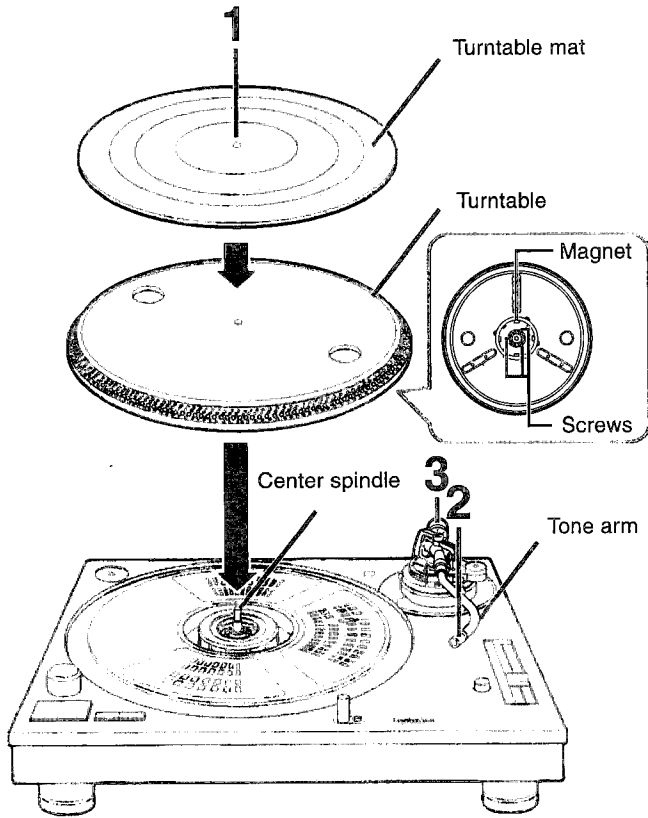
No.	Name	Reference page(s)
①	EP record adaptor	9
②	Turntable base	5
③	Turntable mat (Or disc slip sheet)	6
④	Turntable	6
⑤	Center spindle	6
⑥	Strobe mirrors	10
⑦	Power switch (power)	9
⑧	Strobe light, pilot lamp	9
⑨	Start-stop button (start-stop)	9
⑩	Speed select buttons (33, 45)	9
⑪	Shell stand	5
⑫	Arm-height control	8
⑬	Balance weight	6
⑭	Stylus pressure control	7
⑮	Arm lock	8
⑯	Anti-skating control	7
⑰	Cue lever	7
⑱	Arm clamp	7
⑲	Arm rest	7
⑳	Tone arm	6
㉑	Pitch indicator	10
㉒	Pitch control (pitch adj.)	10
㉓	Reset button (reset)	9
㉔	Locking nut	6
㉕	Head shell	6
㉖	Stylus light switch	9
㉗	Stylus light	9

Putting the player together

In order to prevent damage during shipping some of the equipment has been disassembled.

Put the player together in the following order.

- Do not connect the AC mains lead until set up is complete.
- Leave the dust cover off until set up and adjustments are complete.



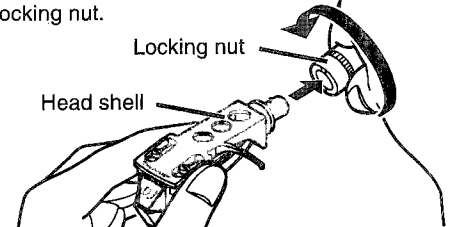
1 Fit the turntable and turntable mat.

Put the turntable on the center spindle and then lay the mat on top.

- Be very careful when putting the turntable on the main unit. The magnet on the bottom of the turntable is finely adjusted and sharp contact can cause it to move and lead to poor operation. Ensure the magnet remains free from dust and iron particles.
- Do not adjust the screws attaching the magnet to the turntable. The rated performance of the unit cannot be guaranteed if the magnet is moved.

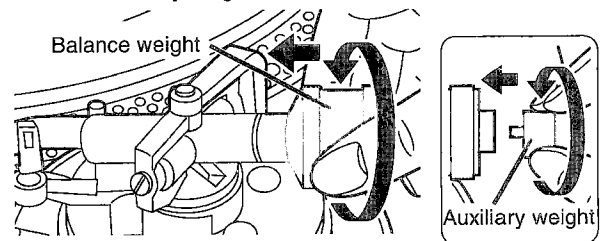
2 Attach the head shell.

Fit the head shell into the tone arm, keep it horizontal and tighten the locking nut.



3 Attach the balance weight to the rear of the tone arm.

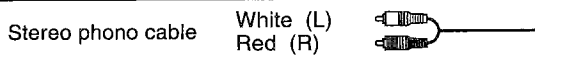
If the cartridge weighs between 10 and 13 grams, attach the included auxiliary weight to the main balance weight.



Connections and installation

Connecting to an amplifier and AC mains lead

1. Connect the PHONO earth lead and stereo PHONO cables to the amplifier PHONO terminals.



- If the earth lead isn't connected, a hum will be heard from the AC power source.
- You will not have adequate volume or sound quality if connecting to an amplifier that has no PHONO terminals.

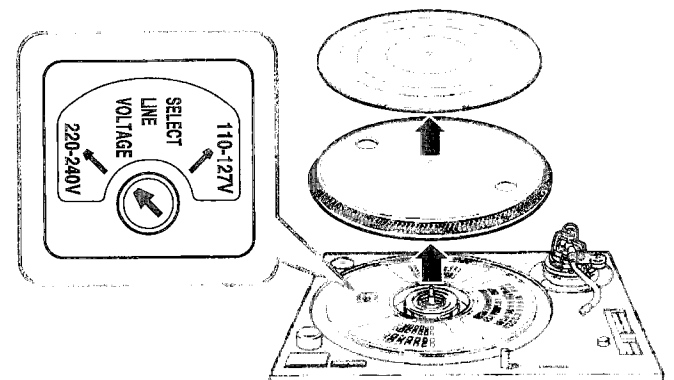
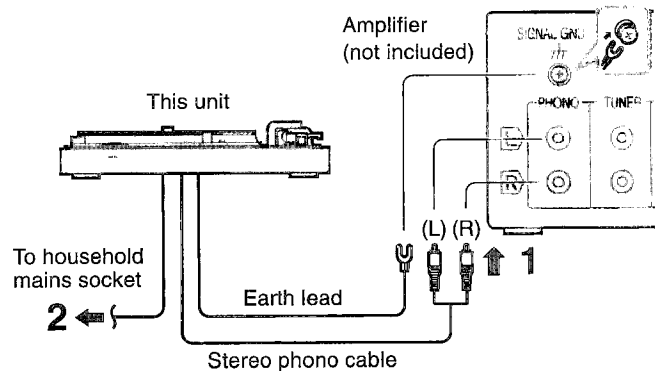
For the United Kingdom:
BE SURE TO READ THE CAUTION FOR THE AC MAINS LEAD ON PAGE 4 BEFORE PROCEEDING TO STEP 2.

2. Connect the AC mains lead.

- Connect this cord only after all other connections are complete.
- Confirm the wattage of AC outlets on amplifiers and receivers before using them for this unit. This unit consumes 14 W.

For your reference

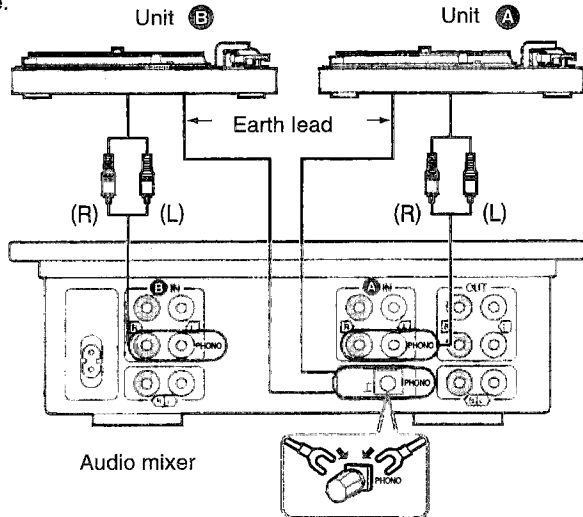
There is an AC line-voltage selector under the turntable. This allows you to change the voltage if you move to an area with a lower voltage. Check the voltage of your area before using the unit. If the selector needs to be changed, turn it with a screwdriver.



Connections and installation

Connecting to an Audio Mixer (not included)

- Disconnect all units from the power source before making any connections.
- Reconnect the AC mains leads after all other connections are complete.



Installation

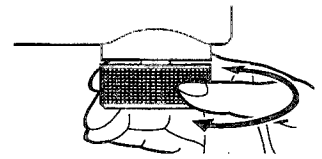
- Install the unit on a horizontal surface protected from vibrations.
- Keep this unit as far as possible from speakers.

Note

- Ensure the unit is not exposed to direct sunlight, dust, humidity, and heat from a heating appliance.
- This unit may pick up interference from a radio if there is one nearby. Keep radios as far as possible from this unit.

Adjusting the height of the insulators

Place the unit where it is to be used and adjust the height of the legs to make the unit horizontal.

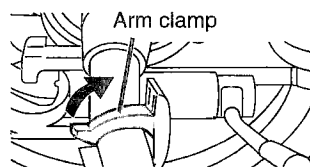


Preparatory adjustments

Horizontal balance and stylus pressure

1 Release the tone arm.

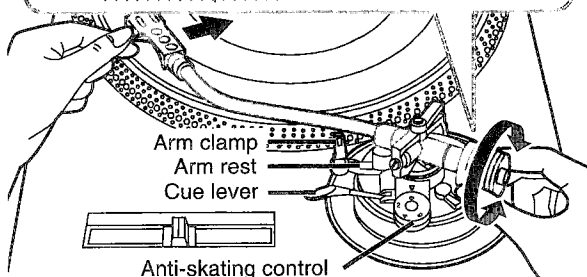
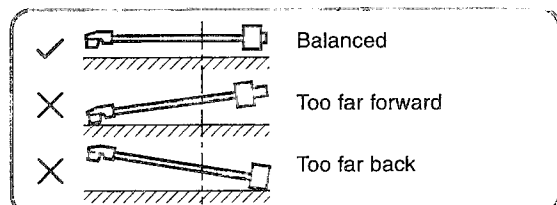
1. Remove the stylus cover, taking care not to damage the stylus, then release the arm clamp.
2. Free the tone arm from the arm rest.



2 Adjust horizontal balance

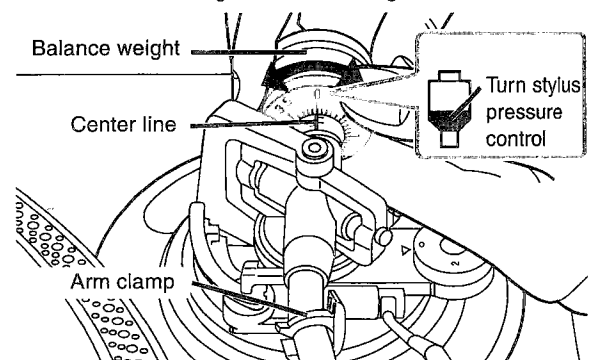
1. Push the cue lever down.
2. Turn the anti-skating control to "0".
3. Turn the balance weight until the arm is approximately horizontal.

Take care at this time not to allow the stylus to touch the unit.



3 Turn the stylus pressure control to "0"

1. Return the tone arm to the arm rest and fix it with the arm clamp.
2. Turn the stylus pressure control to "0". Hold the balance weight still while doing this.

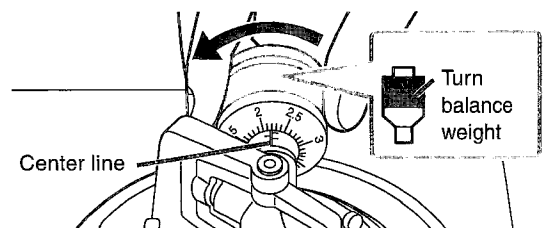


4 Adjust stylus pressure

Turn the balance weight to adjust to the appropriate pressure for the cartridge you are using.

See the cartridge's instructions for recommended stylus pressure.

The stylus pressure control will turn at the same time. Stop when the center line points to the required pressure.

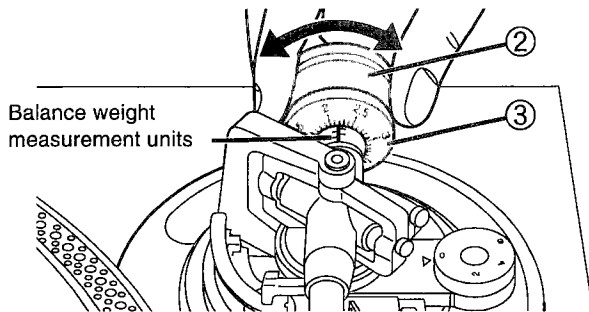


Preparatory adjustments

Using the balance weight control

Make note of the balance weight setting for your stylus cartridge, you can quickly change the stylus pressure without having to re-adjust the horizontal balance of the arm each time you remove and re-attach the stylus cartridge.

- ① Attach the cartridge to the tone arm you are using.
- ② Turn the balance weight control to the setting you previously used to balance the weight including cartridge.
- ③ Turn the stylus pressure control dial to the setting you previously used to balance the weight including cartridge.

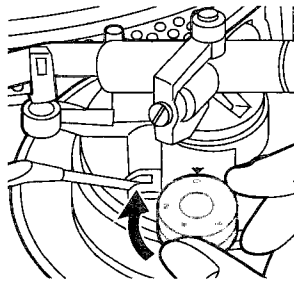


Anti-skating

Adjust the dial to the same value as the stylus pressure control when playing normal music.

For scratch play

Adjust the control to reduce skipping.



Armlift height

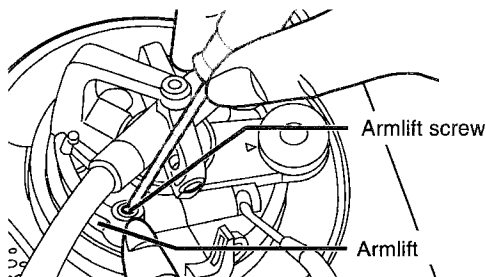
Preparation

1. Put a record on the turntable.
2. Take off the stylus cover and release the arm clamp.

Use a screwdriver to turn the armlift screw.

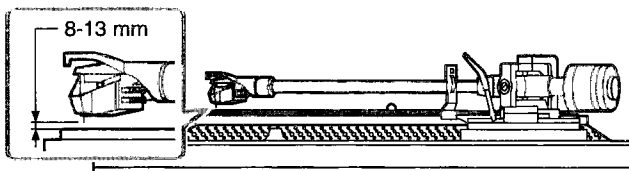
Make this adjustment only if the cartridge you are using makes it necessary.

- Turning the screw clockwise lowers the armlift.
- Turning the screw anti-clockwise raises the armlift.



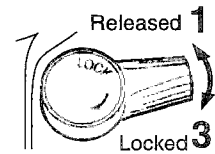
Note

Armlift height (the distance between the record and stylus when the cue lever is raised) is set to between 8 and 13 millimeters at time of shipment.



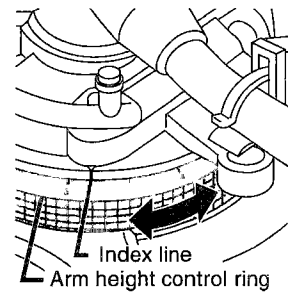
Tone arm height

1. Release the arm lock.



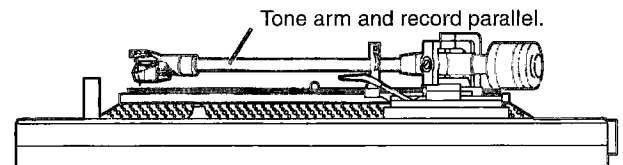
2. Adjust the arm height.

- Adjust the ring using the chart below as reference so the arm height matches the indicated height of the cartridge. Measurements are marked on the arm height control ring in 0.5 millimeter intervals.



Cartridge height (H) in millimeters	Height control position
17	0
18	1
19	2
20	3
21	4
22	5
23	6

- If you do not know the height of your cartridge, rest the stylus on a record and adjust the height control until the tone arm and record are parallel.



3. Lock the arm after adjusting the height.

Fit the dust cover

Hold the dust cover with both hands and fit it over the player from directly above.

